

## Sink Quadra R12 Gun Metal Fumè

Kitchen Sinks

Code: 1715 016

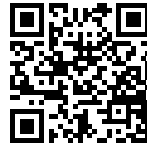

### DETAILS

Material AISI 304 stainless steel

Finish PVD

Coloring Gun Metal

Texture Fumé

Edge/Installation Type Flush-mount | Top-mount

Base 60 cm

Dimensions 540 x 440 mm

Bowl dimension 500 x 400 mm

Width 54 cm

Built-in hole

[View technical data sheet](#)

Number of bowls

1 bowl

Standard fittings

Fixing hooks, gasket, drain, overflow and siphon, boxed packing

Drainer

No

Mixer holes

No standard holes

Waste fitting

Drain SPACE 3,5"

## FEATURES

Deep bowls

This bowls reach an important depth, over 20 cm, thanks to the advanced production technology, that can be offer great capieny and practicity in all the washing operations.

Diamond-shape bottom

The draining of water is an important feature in a sink, and it's always taken good care of in Foster products. In the bent-welded sinks, which would have a flat bottom, the proper draining is guaranteed by the elegant beveling, which helps the water flow.

GUN METAL FUMÈ

The Gun Metal Fumè finish is obtained by treating steel with a physical process called PVD (Physical Vacuum Deposition) which deposits particles of noble metals on the surface. The result is a unique and refined aesthetic effect, and an improvement of the mechanical properties of the steel which is more resistant to impact and scratches.

High thickness

1mm thick steel. A significant thickness, which guarantees the maximum sturdiness and durability.

Perimetral overflow

The overflow is always a security on the Foster sinks that prevents the overflow of water in case of oversights. The perimeter drain solution improves aesthetics thanks to its square and essential shape.

Small radius

Bowls with squared shapes with a modern design and an increased capacity, for a minimal aesthetics connected with an extreme practicity.

## TECHNICAL DATA

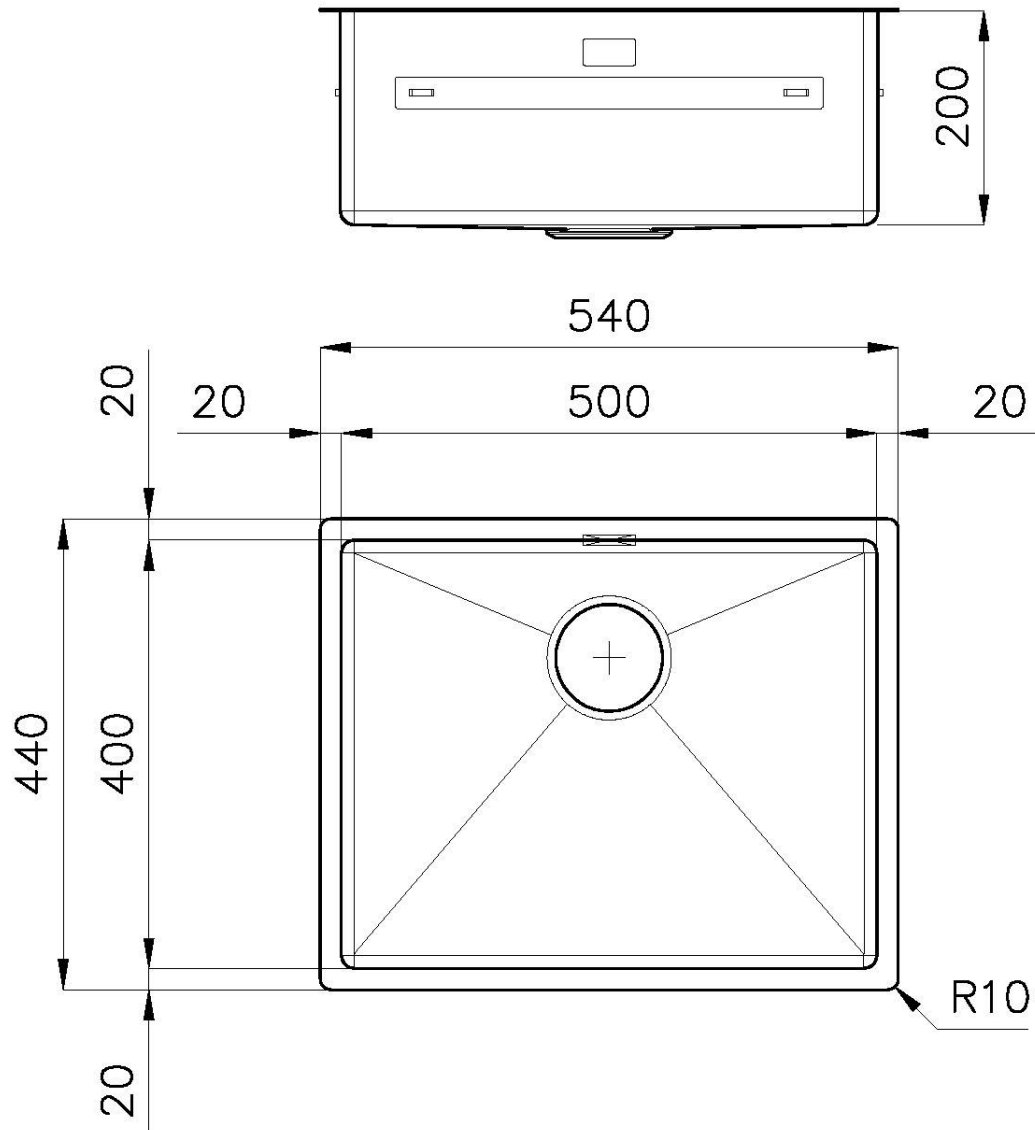



8100 617  
POSIZIONATA A FILO VASCA / EDGE POSITIONING



8100 617  
POSIZIONATA SUL FONDO / BOTTOM POSITIONING



intaglio per il troppo-pieno  
solo con top > 30 mm  
recess for housing the over-flow  
only for top > 30 mm

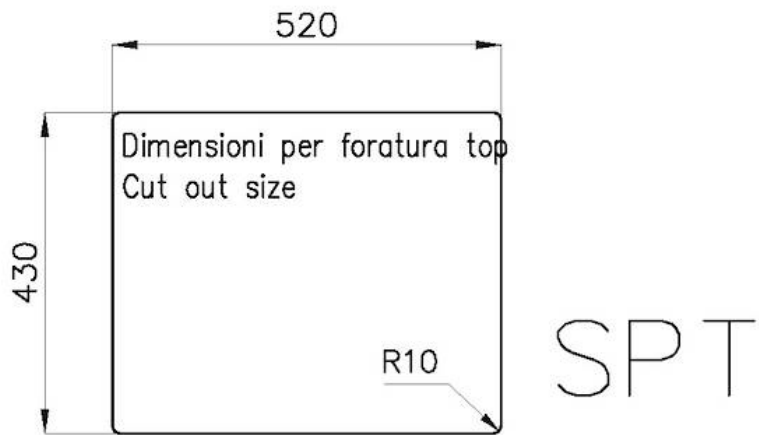
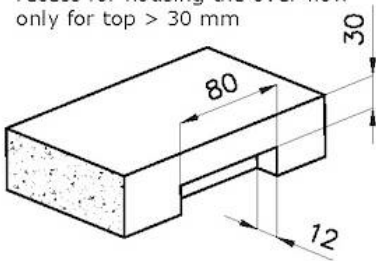

## GALLERY



## EQUIPMENT



**Black grid**  
8100 617

## OPTIONAL ACCESSORIES



**Glass chopping board**  
8631 300



**Graters kit with ring-holder and food collection tray**

8159 101

\* only in combination with the accessory

8644 101



**HDPE Chopping board**  
8657 001



**HPDE Twin chopping board**  
8644 101



**Iroko-wood sliding chopping board with stainless steel colander**

8644 044



**Stainless steel perforated tray**  
8151 000

\* only in combination with the accessory  
8644 101



**Stainless steel perforated tray PVD  
Copper**

8151 008

\* only in combination with the accessory  
8644 101



**Stainless steel perforated tray PVD  
Gold**

8151 009

\* only in combination with the accessory  
8644 101



**Stainless steel perforated tray PVD  
Gun Metal**

8151 006

\* only in combination with the accessory  
8644 101



**Stainless steel plate rack**

8100 303

\* only in combination with the accessory  
8644 101

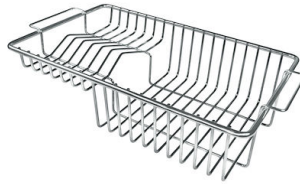

**Stainless steel plate rack**

8100 201



**White bowl**

8153 100

## RECOMMENDED PAIRINGS

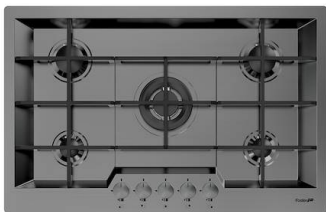

**Cooker hob KE Gun Metal**

7601 632

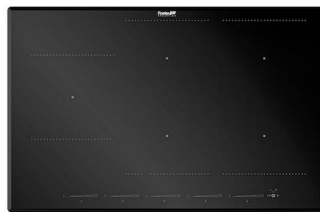

**Cooker hob KE Induction**

7386 646



**Mixer Tap Omega Plus Gun Metal**

8498 856

## OPTIONAL AUTOMATIC WASTE FITTINGS



**Space Push Gun Metal automatic  
waste fitting - PO**

8407 120